

Varenummer: 2301044411  
 Beskrivelse: E+G Håndsving  
 MT.130 AS-14x14

## Mål

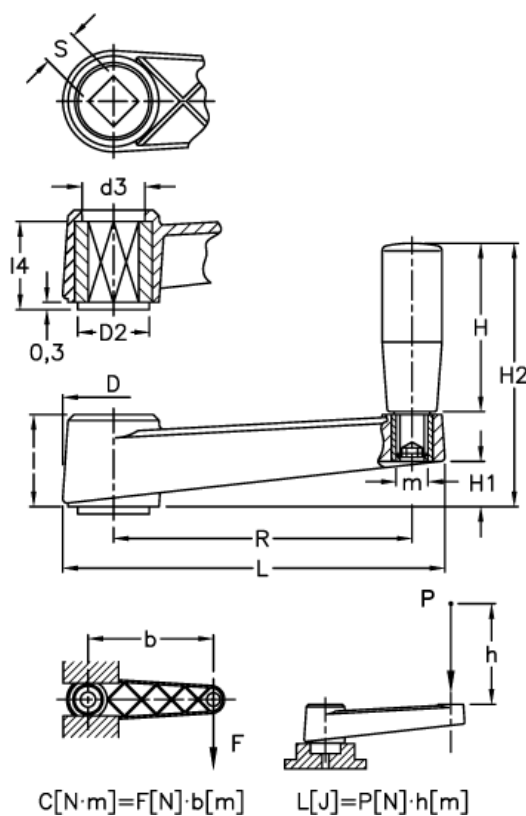

C (N*m)	= 350	L	= 162
D	= 40	L(J)	= 45
d2	= 28	l4	= 30
d3	= 25	m	= M8
H	= 80	R	= 130
H1	= 20	S H9	= 14x14
H2	= 115		
l	= 35		